













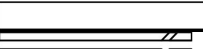
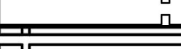



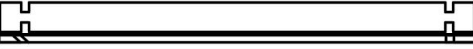

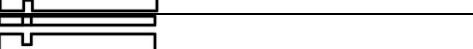

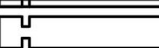

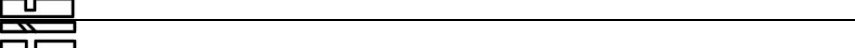
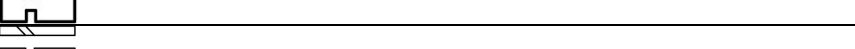



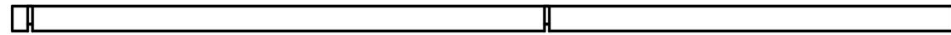
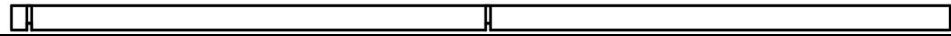
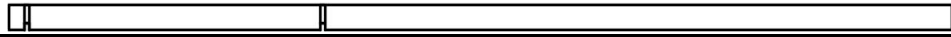
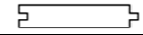
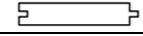
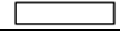
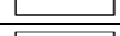

Sunflower plus 3m x 3m + terrace

Nr.	Item	Height	Width	Length		Qty
Floor Bearers						
1b	Floor Bearers	35	55	4940		7
Walls						
8	Wall A	110	28	1760		9
9	Wall A	110	28	525		9
10	Wall A	110	28	525		9
11	Wall A	110	28	128		1
12	Wall A	110	28	860		1
13	Wall A	110	28	703		1
14	Wall B	110	28	3000		18
15	Wall B	110	28	128		2
16	Wall B	110	28	860		3
17	Wall C	55	28	1760		1
18	Wall C	110	28	1760		8
19	Wall C	55	28	1760		1
20	Wall C	110	28	525		9
10	Wall C	110	28	525		9
21	Wall D	55	28	3000		1
14	Wall D	110	28	3000		18
22	Wall D	55	28	3000		1
23	Wall E	55	28	232		1
24	Wall E	110	28	232		17
25	Wall E	110	28	232		1
26	Wall E	110	28	232		18
27	Wall E	110	28	142		1
28	Wall E	110	28	1245		1

29	Wall E	110	28	468		1
Purlins						
30	Purlins	130	43	5120		2
31	Purlin	130	43	5120		1
32	Purlin	130	43	5120		1
Boards						
1a	Roofboards	110	20	3000		48
2a	Floorboards	110	20	2780		27
	Terrasse fb	105	20	3000		21
3a	Windboard	105	20	5160		2
5a	Windboard	105	20	3000		2
6a	Trims	25	35	2784		5
7a	Roof plank borders	25	35	10240		
33	Support	100	60	2400		4
34	Planche de rive pour couverture	60	16	3000		2
35	Planches de terrasse	90	18	3000		30
Door and windows						
1c	Double door	1870	28	1440		1
2c	Single windows	970	28	700		2

Foundation

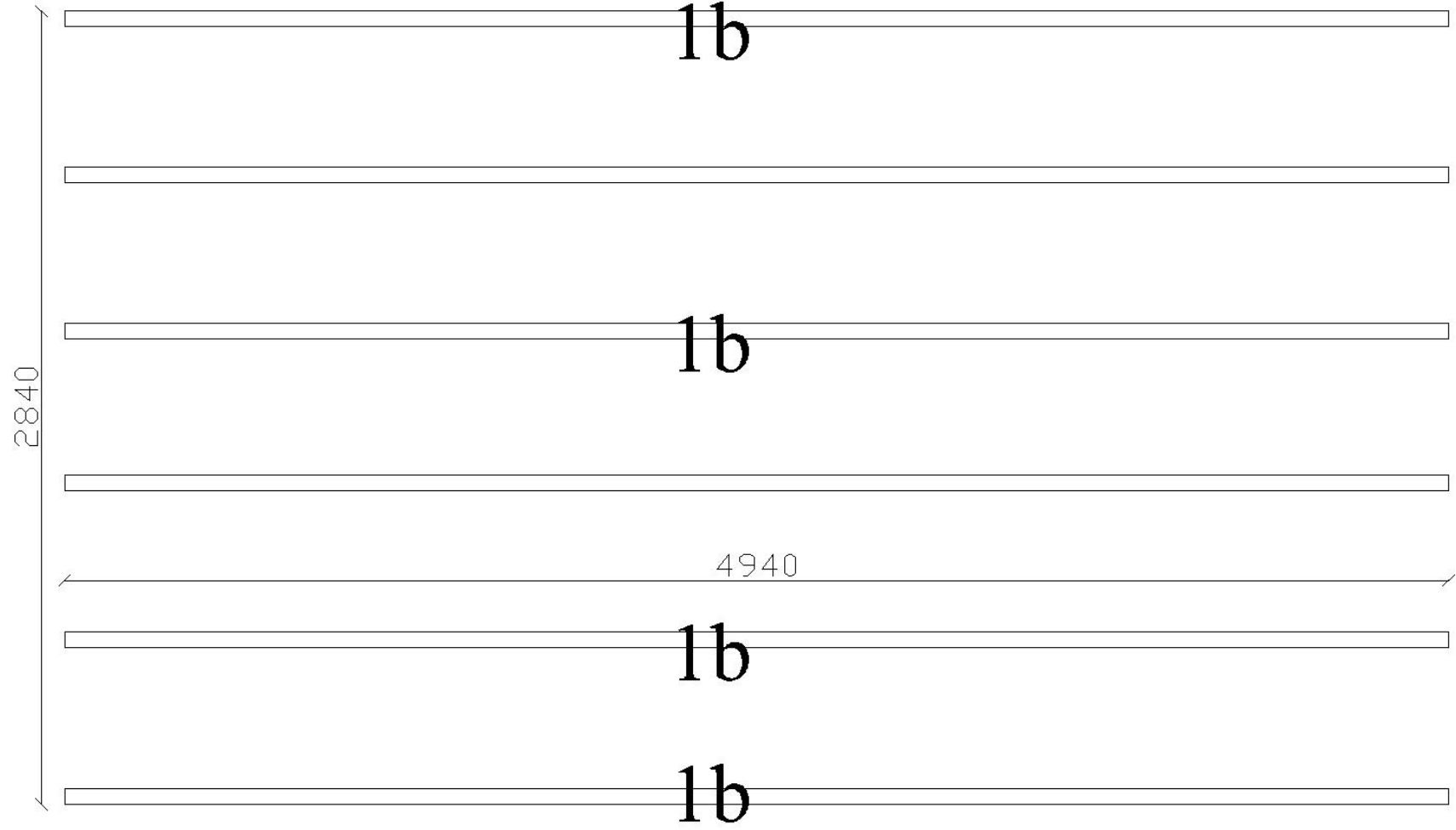

Floor Boards

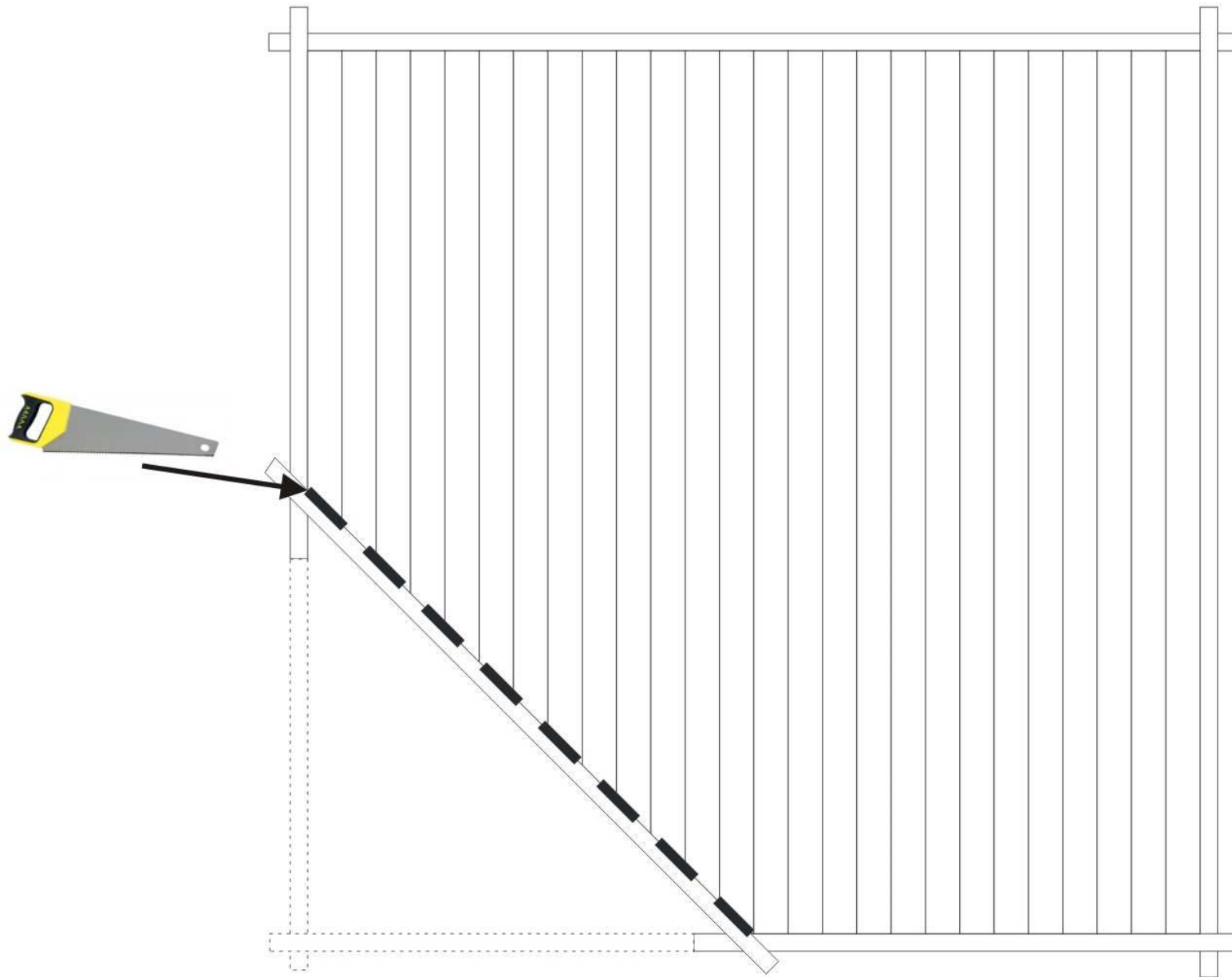

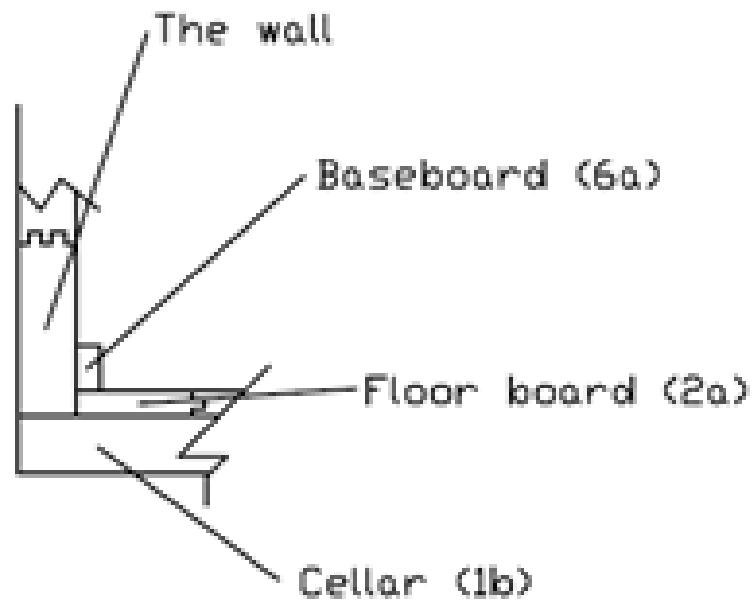

Plan of the walls

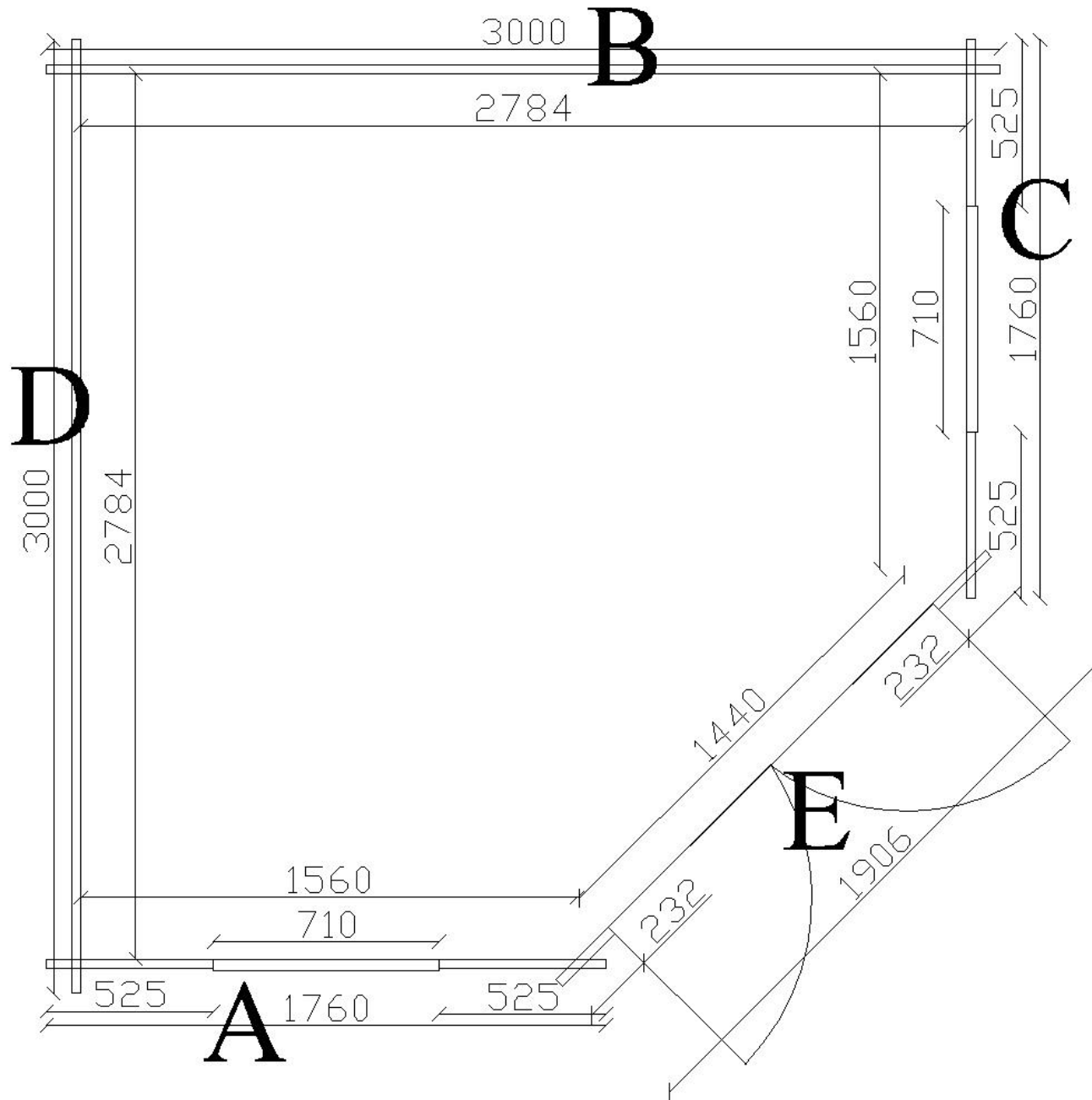

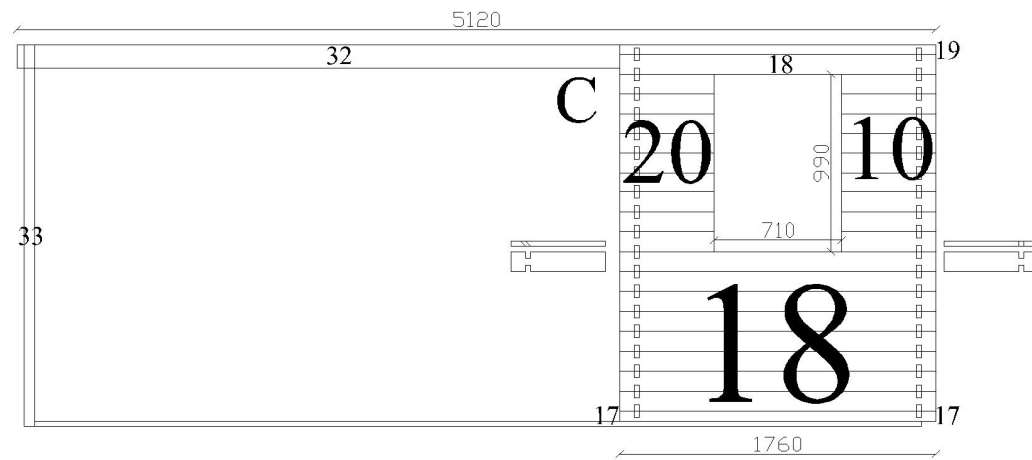
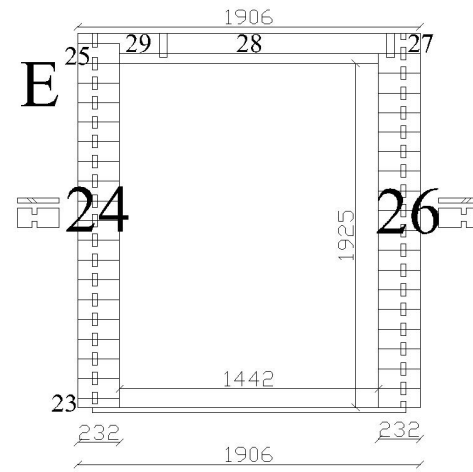
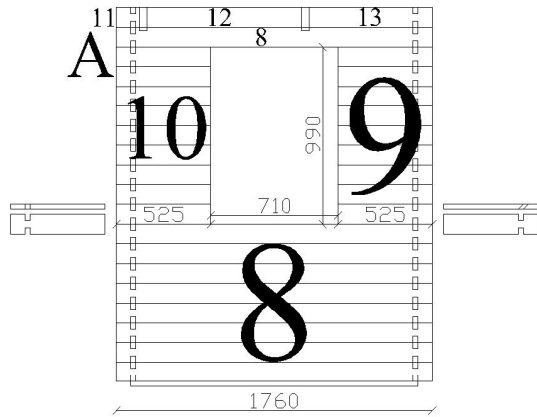
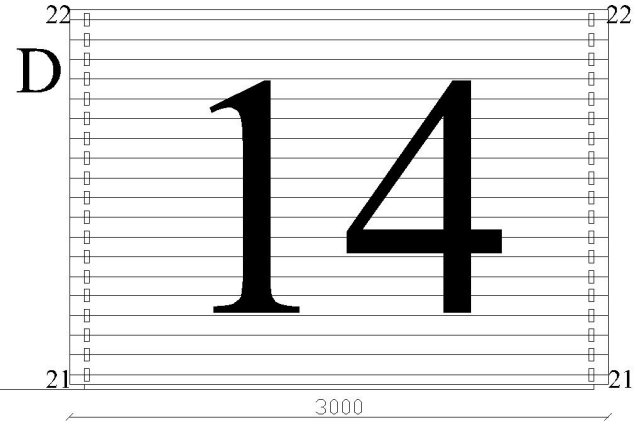
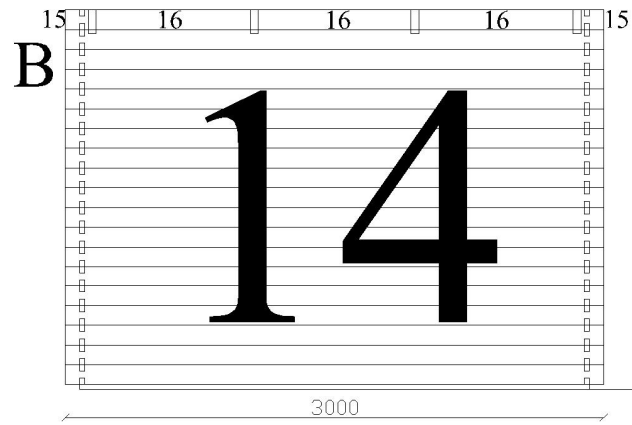

PURLINS

3000

B

C

D

3000

E

A

30

30

31

32

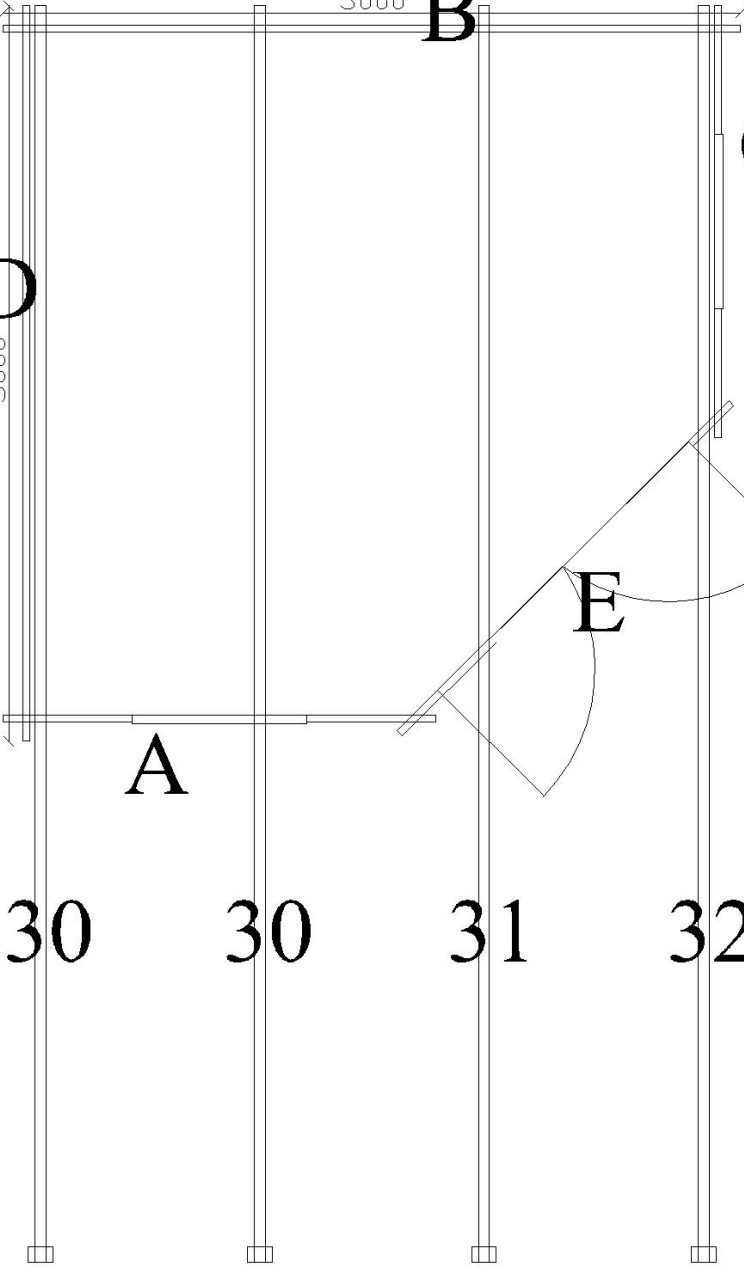

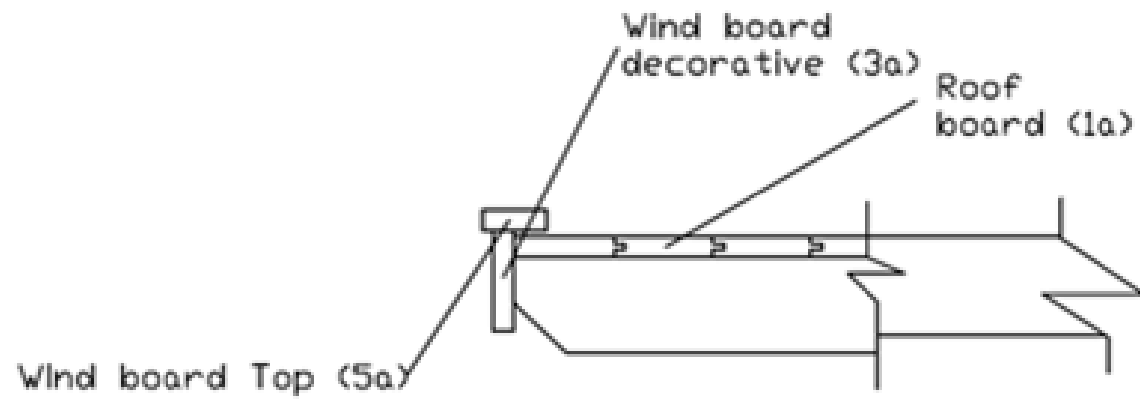
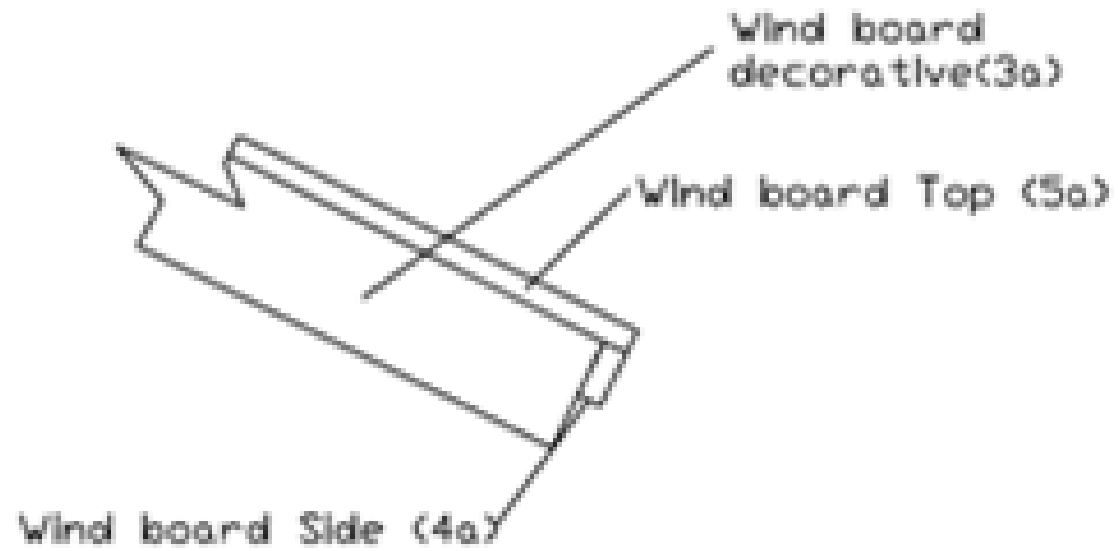

Bitumen shingles

