













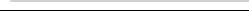



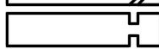
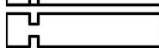

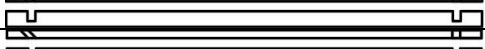





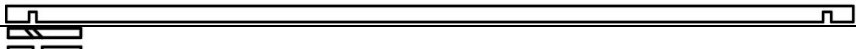
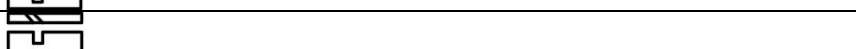





Sunflower 3m x 3m (28mm) Installation

Nr.	Item	Height	Width	Length		Qty
Floor Bearers						
1b	Floor Bearers	40	55	2840		1
2b	Floor Bearers	40	55	2730		5
3b	Floor Bearers	40	55	2330		1
4b	Floor Bearers	40	55	1880		1
5b	Floor Bearers	40	55	1754		1
6b	Floor Bearers	40	55	1600		1
7b	Floor Bearers	40	55	1545		1
Walls						
8	Wall A	110	28	1760		9
9	Wall A	110	28	525		9
10	Wall A	110	28	525		9
11	Wall B	110	28	3000		18
12	Wall C	55	28	1760		1
13	Wall C	110	28	1760		8
15	Wall C	55	28	1760		1
14	Wall C	110	28	525		9
10	Wall C	110	28	525		9
16	Wall D	55	28	3000		1
11	Wall D	110	28	3000		17
17	Wall D	55	28	3000		1
18	Wall E	55	28	232		1
19	Wall E	110	28	232		17
20	Wall E	55	28	1674		1

21	Wall E	110	28	232		18	
22	Wall E	110	28	1690		1	
Purlins							
23	Boards on top	110	34	3000		4	
24	Boards on top	110	34	1740		1	
25	Cover boards	105	20	3215		4	
26	Purlin	130	40	2312		4	
27	Purlin	130	40	1717		4	
28	Support Roof	150	Ø120			1	
Boards							
1a	Roof boards	3250 x 115 x 20 (40 psc.)					
2a	Floorboards	115	20	2780		7,21 m ²	
3a	Windboard	60	16	3215		2	
5a	Windboard	60	16	3260		2	
6a	Trims	40	19	6000		3	
7a	Roof plank borders	28	43	13000			
Door and windows							
29	Double door	1870	28	1440		1	
30	Single windows	970	28	700		2	

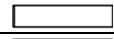
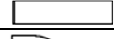
Foundation

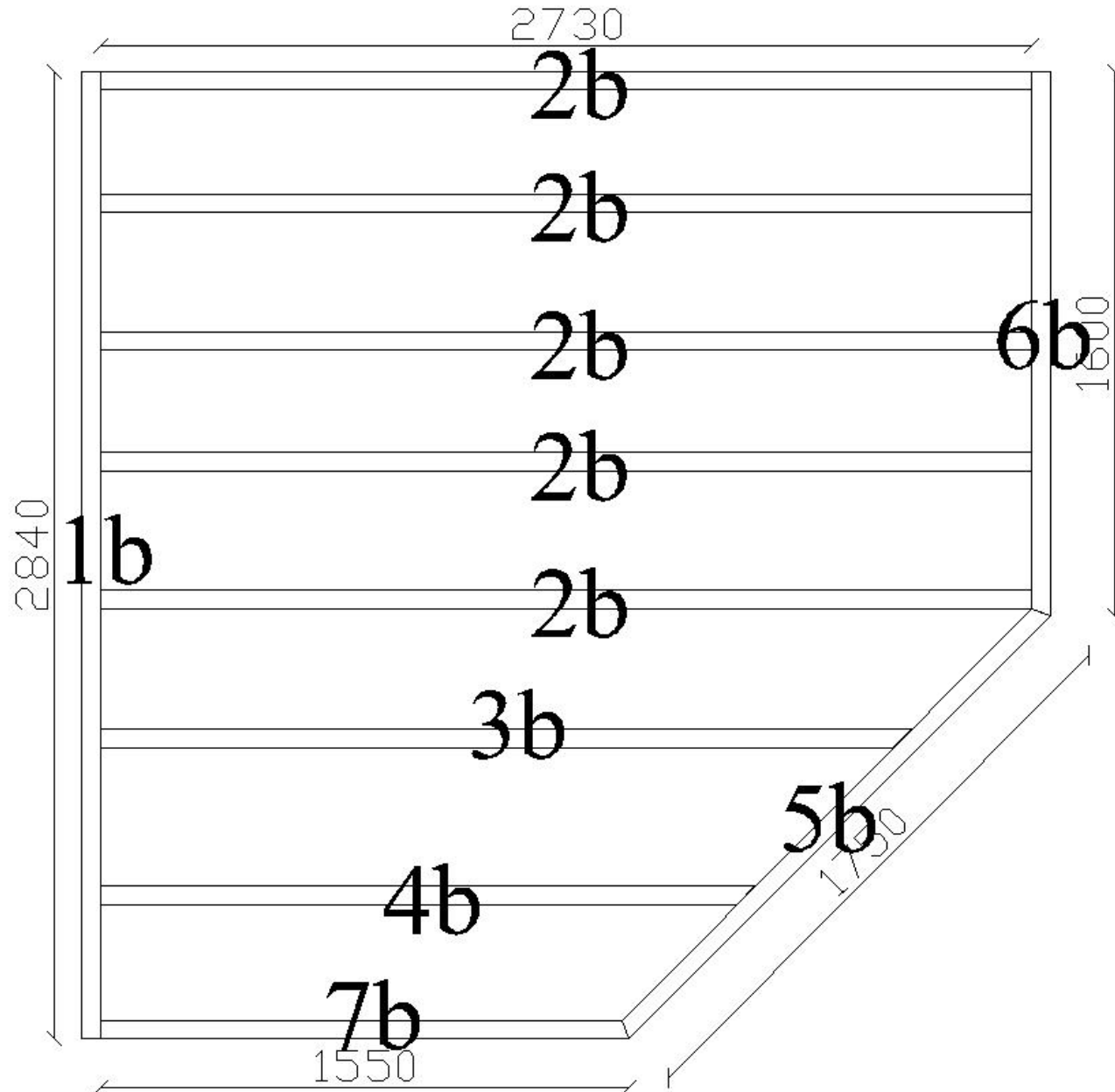

Floor boards

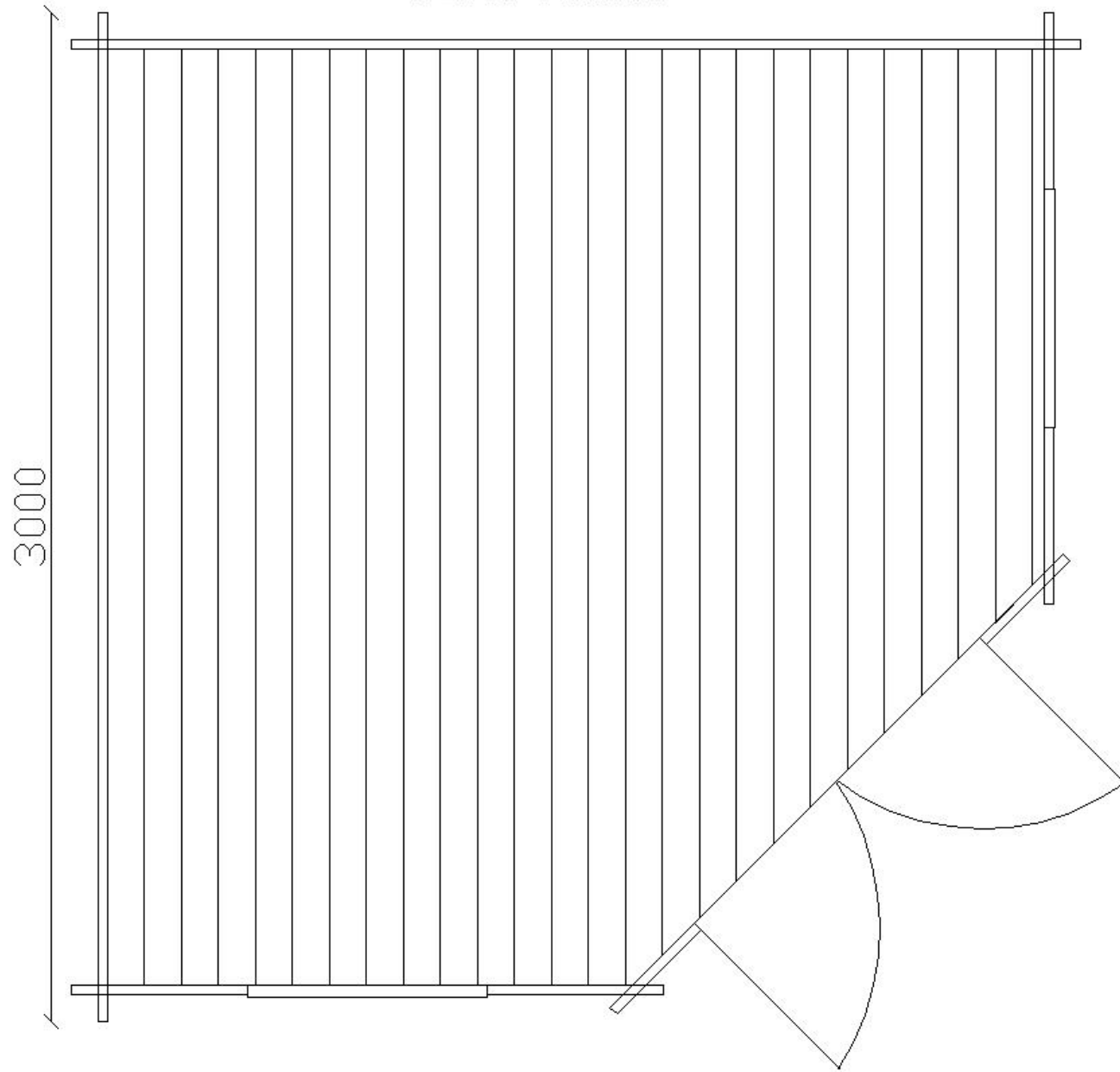

Floor Boards

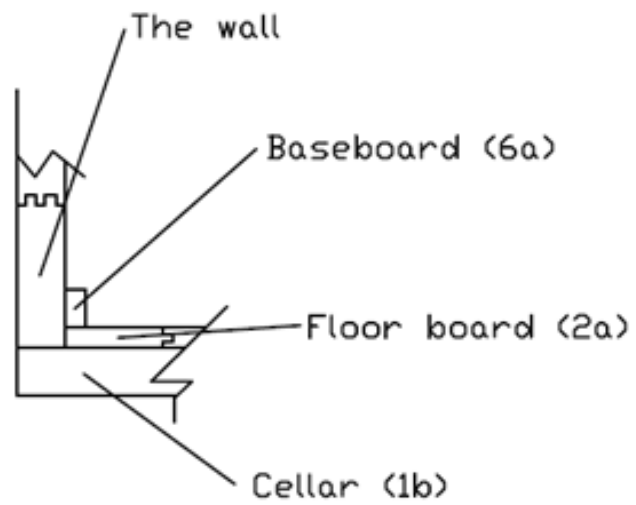
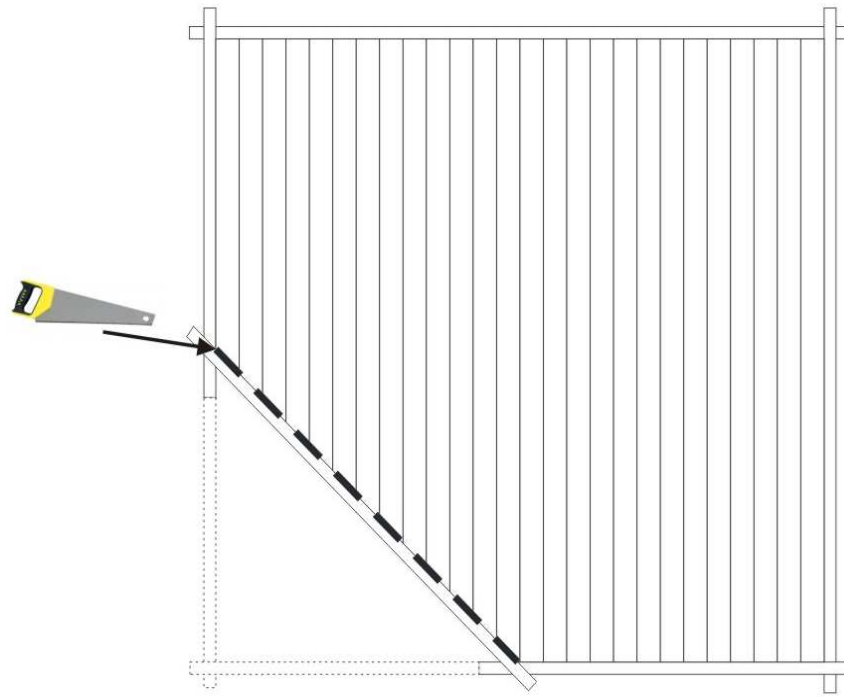

Plan of the walls

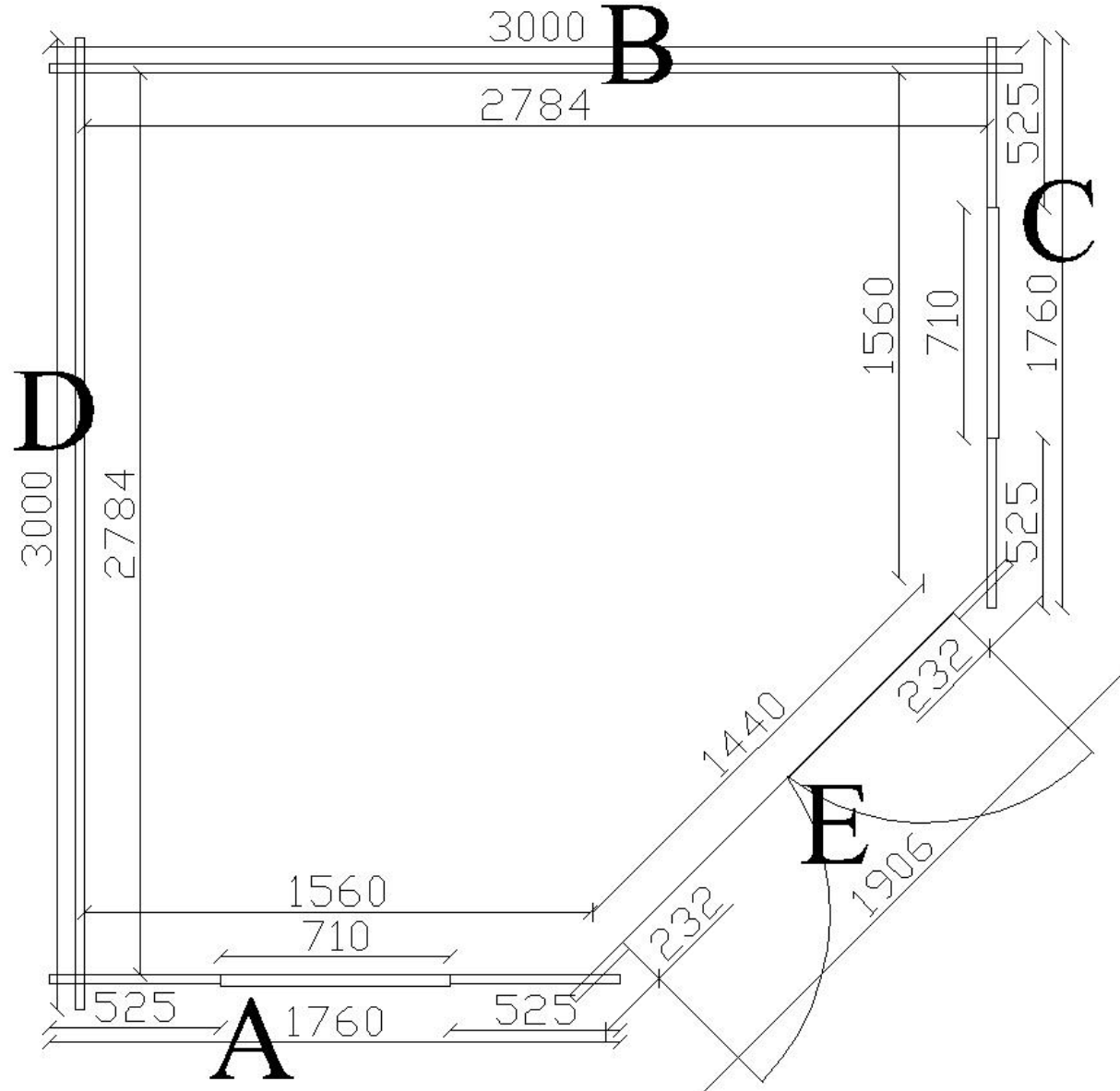

WALLS

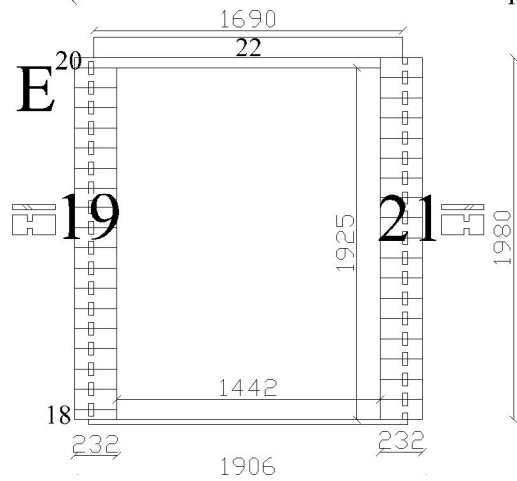
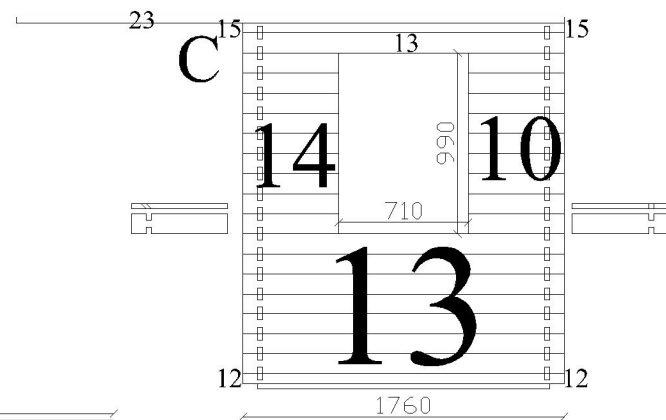
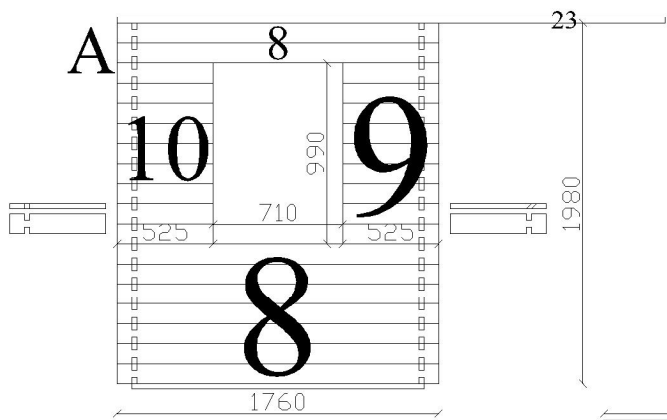
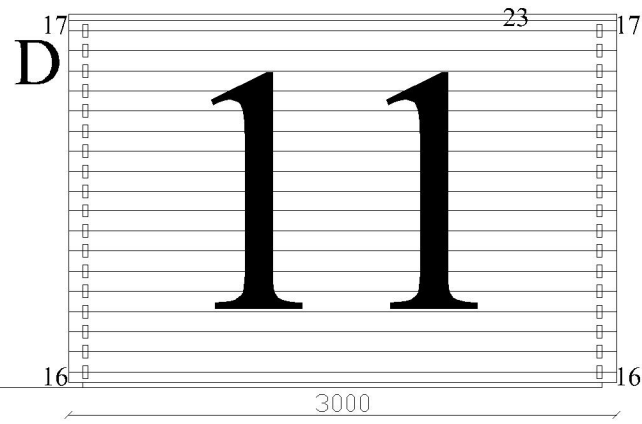
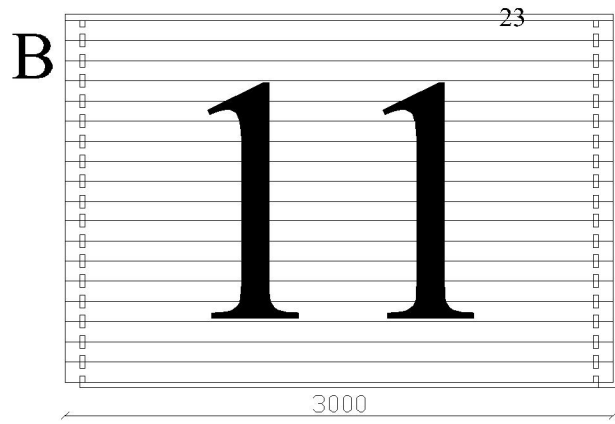

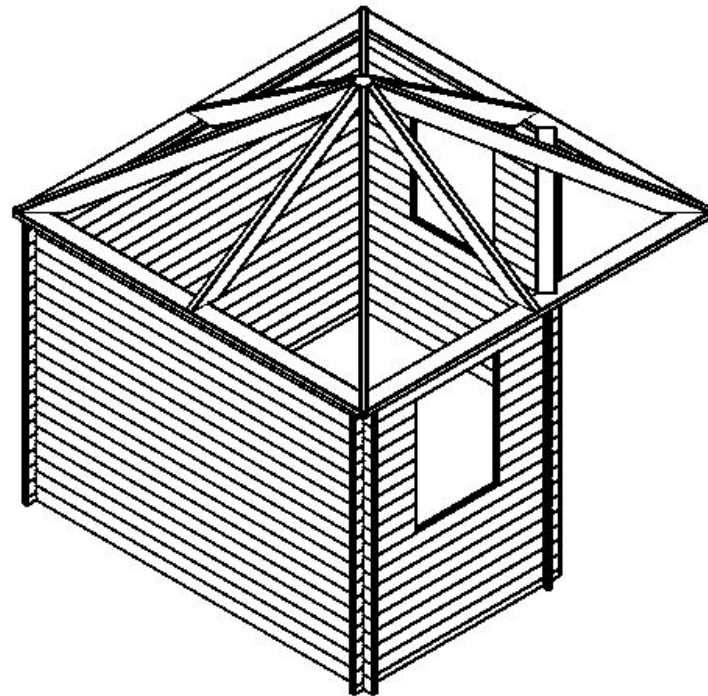
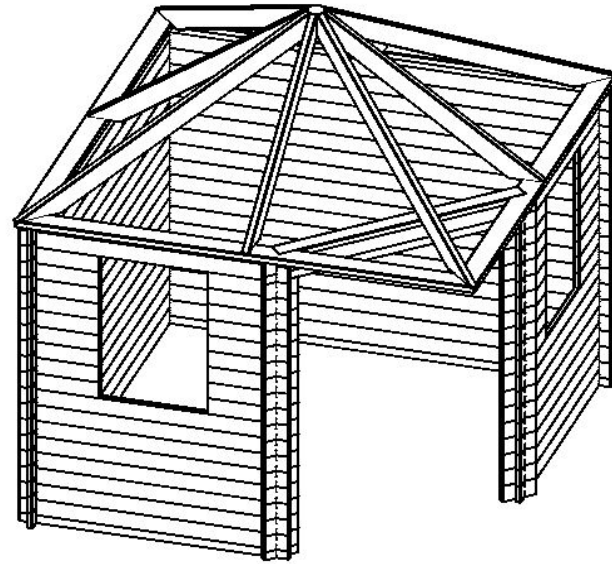

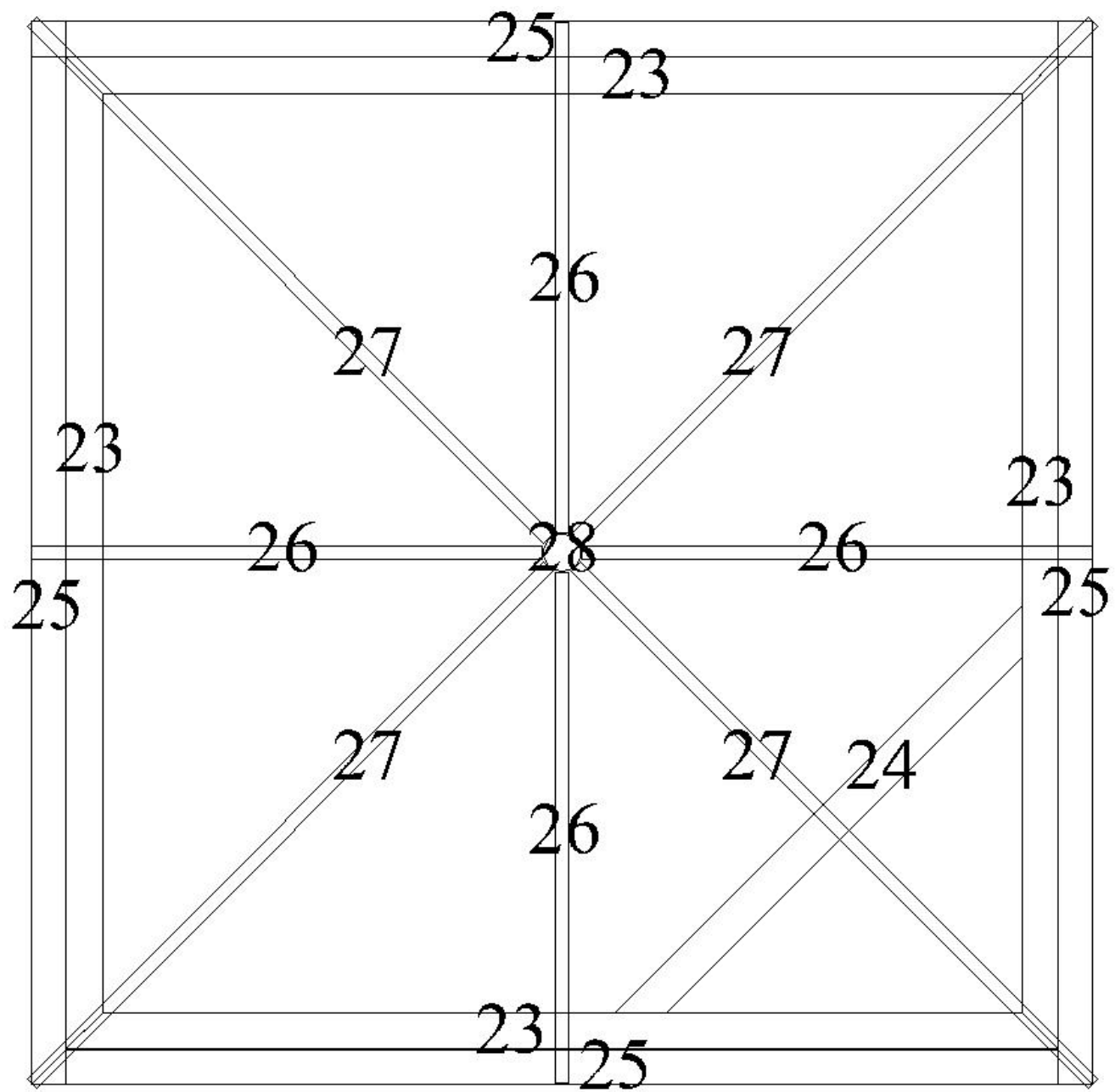

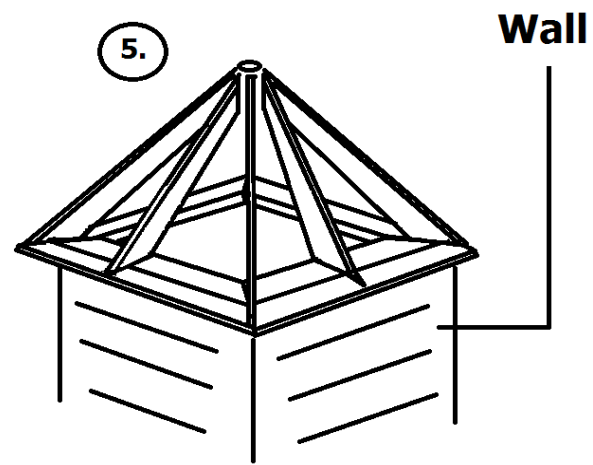
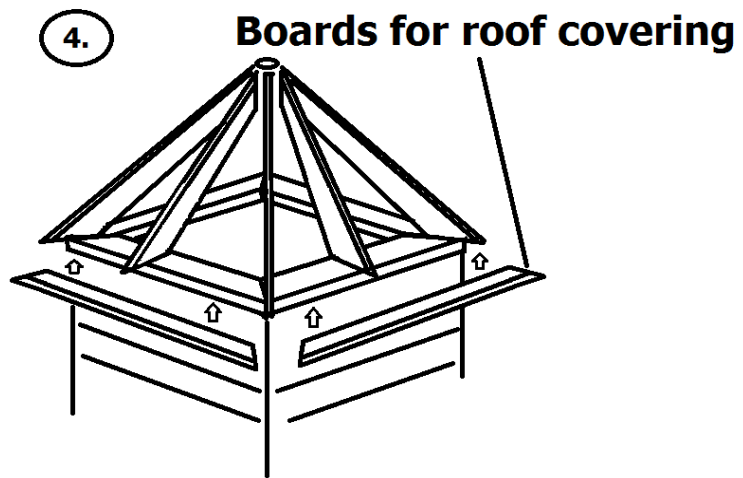
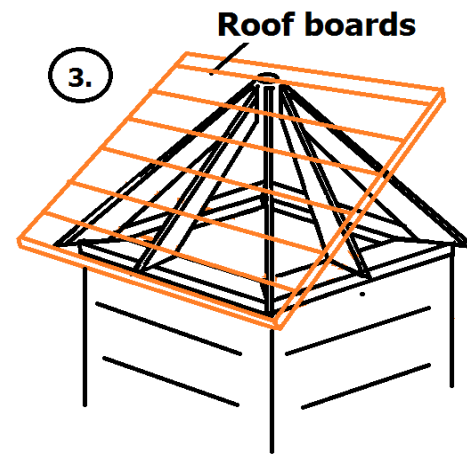
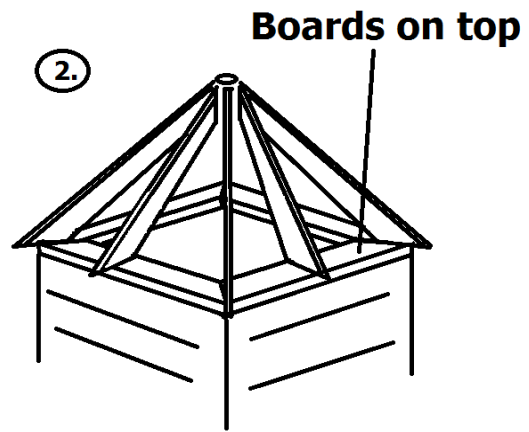
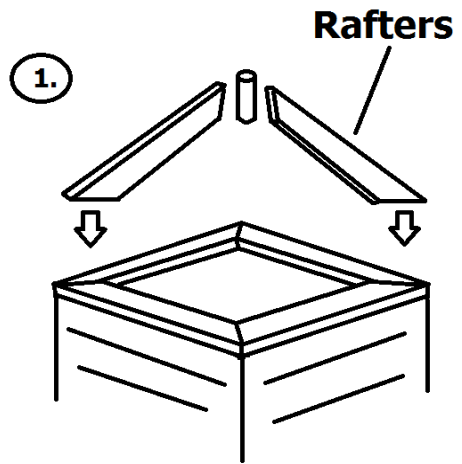

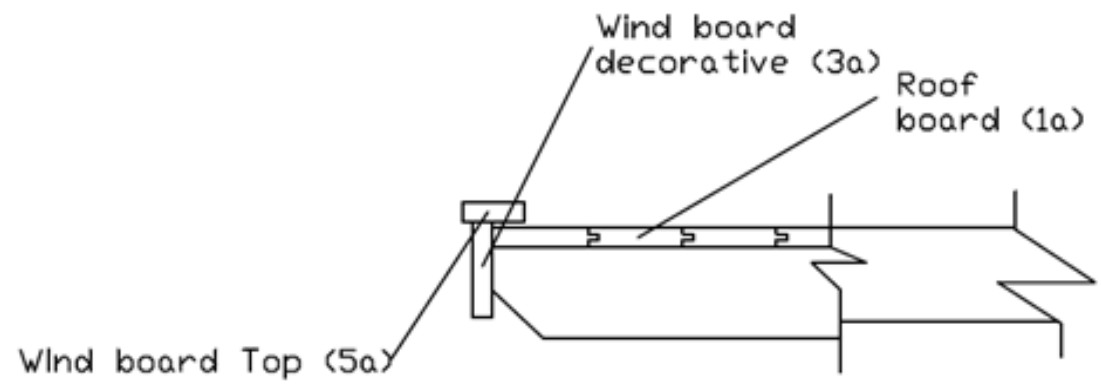
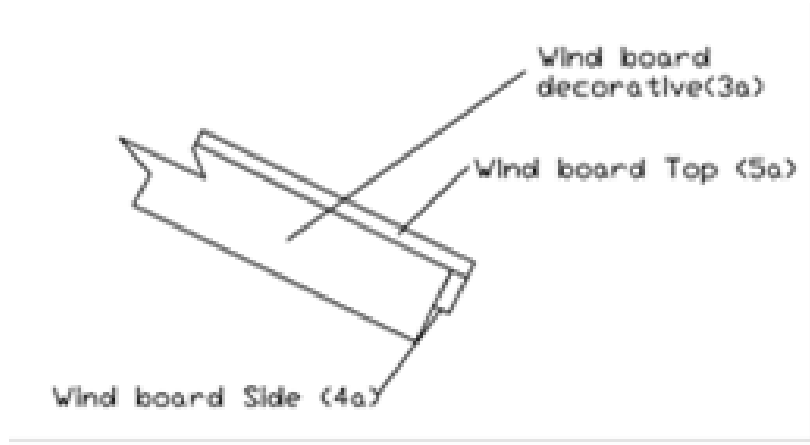

Bitumen shingles

