

























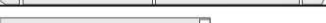





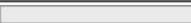







Log cabin Oslo Installation Plans

PRODUCT NAME				OSLO		
REFERENCE NUMBER						
OSLO 5 x4 						
	Size, mm			Detail stock	Details	Annotation
	Length	Width	Table			
1	4000	130	43	15		Wall A
2	4000	65	28	1		Wall A
3	5000	130	43	15		Wall C
4	2957	130	43	14		Wall B
5	2957	65	28	1		Wall B
6	783	130	43	32		Wall B
7	1246	130	43	15		Wall E
8	1246	65	43	1		Wall E
9	2246	130	43	4		Wall D
10	2246	130	43	1		Wall D
11	308	130	43	30		Wall D
12	5340	130	43	1		Wall F
13	5340	130	43	1		Wall C
14	5340	130	60	1		Rafters
15	5340	130	60	1		Rafters
16	5340	130	60	1		Rafters
17	2150	100	60	1		Support board
18	2250	110	18	98		Roof boards
19	2700	100	20	20		Floor boards
20	2745	100	20	29		Floor boards
21	2350	105	20	4		Wind boards
22	2375	105	20	4		Wind boards
23	2375	60	16	4		Wind boards borders
24	5340	105	20	2		Roof plank
25	5340	35	25	2		Roof plank borders
26	2711	35	25	2		Floor boarders
27	2000	35	25	1		Floor boarders
28	1000	35	25	1		Floor boarders
29	3754	35	25	1		Floor boarders
30	4754	35	25	1		Floor boarders
31	4840	50	70	9		Foundation
32	1043	105	20	20		Terrace floor boards
33	300	140	20	2		Decoration
34	4000	660	43	2		Vaults
35	1216	440	43	1		Vaults
36	1920	1615	43	1		Doors
37	1010	1380	43	2		Windows



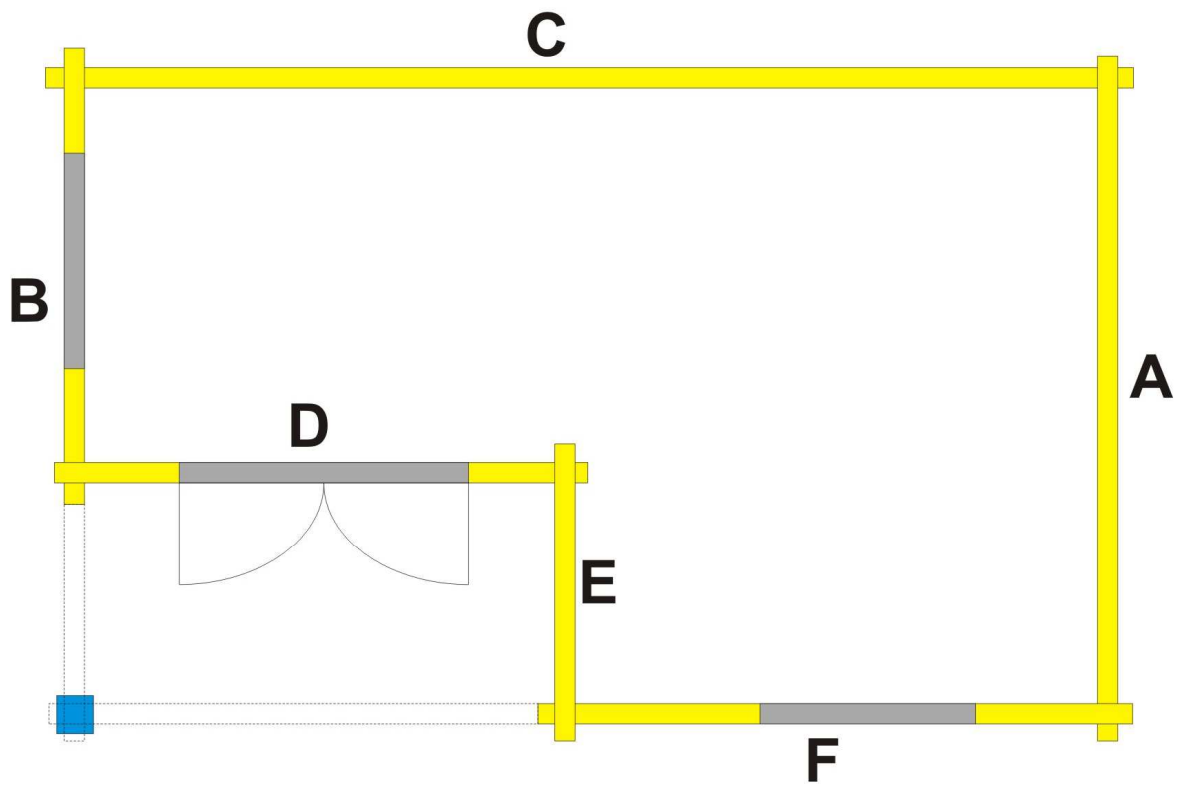
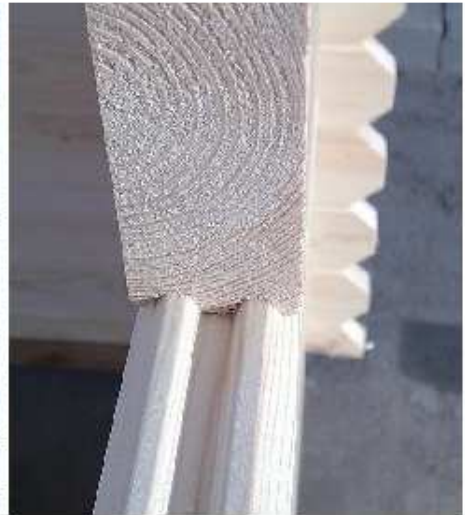
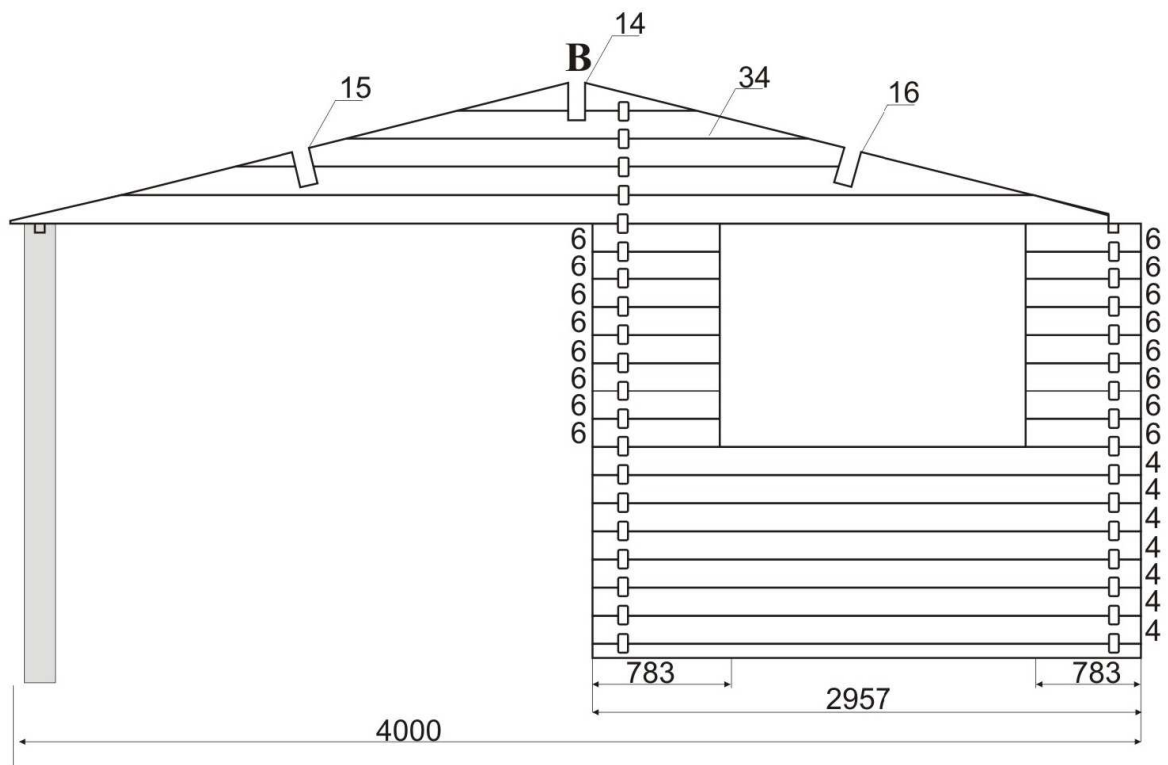
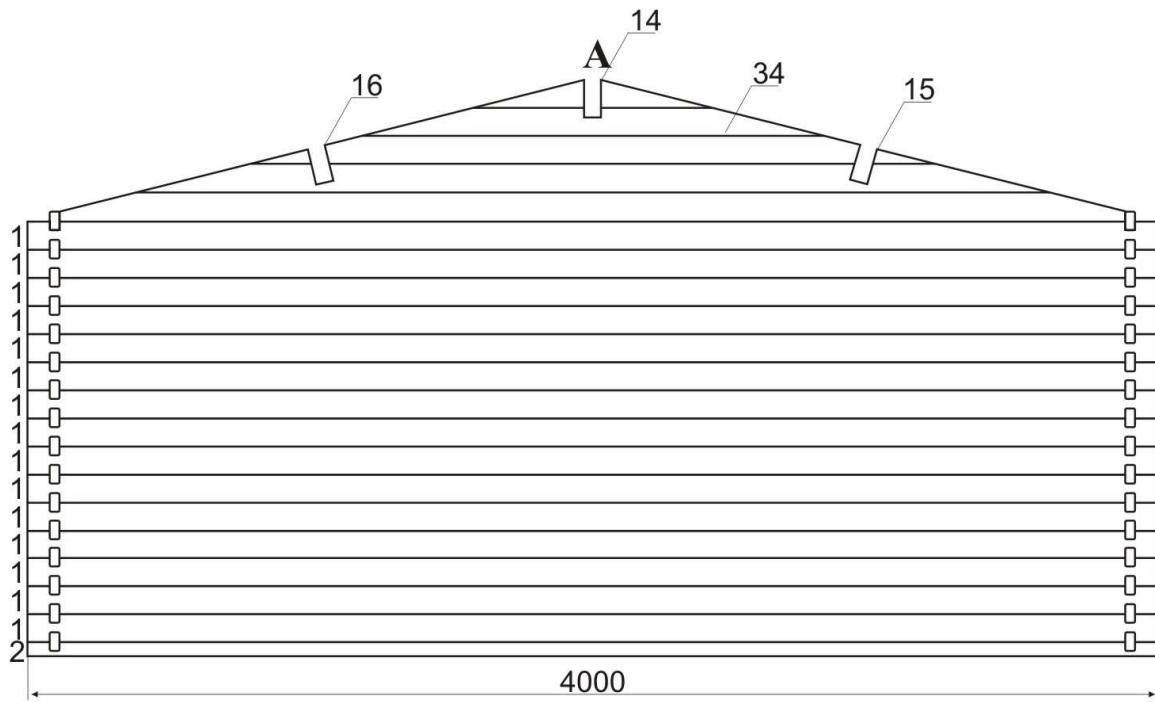

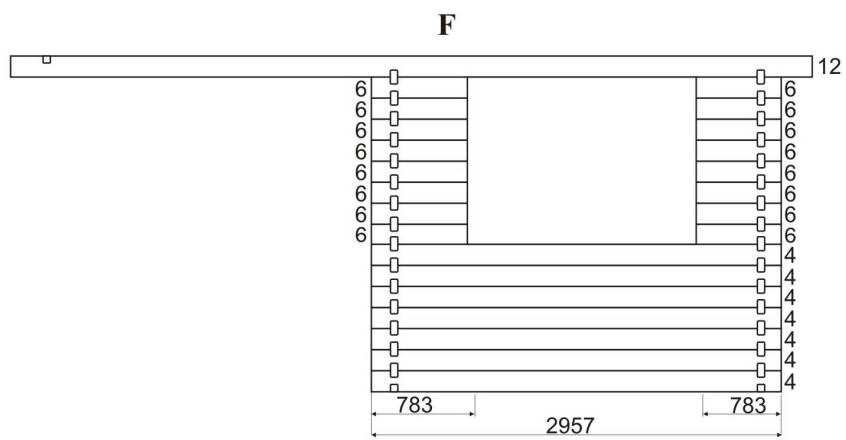
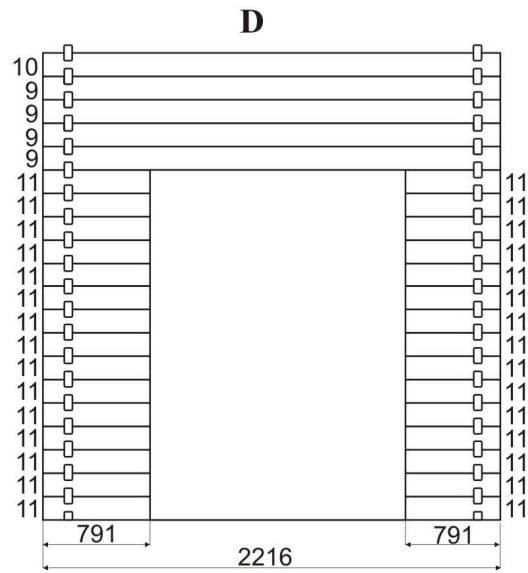
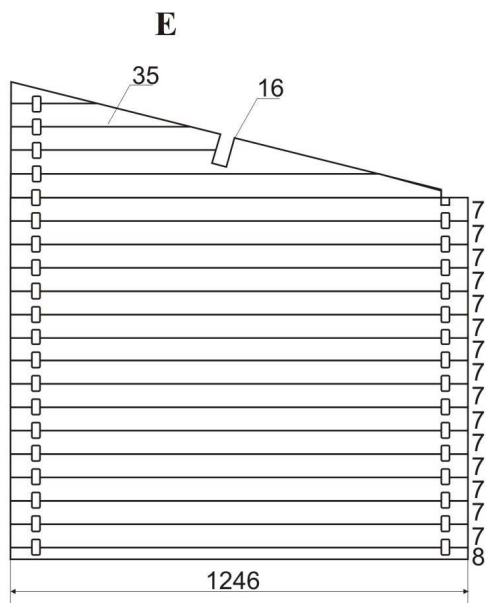
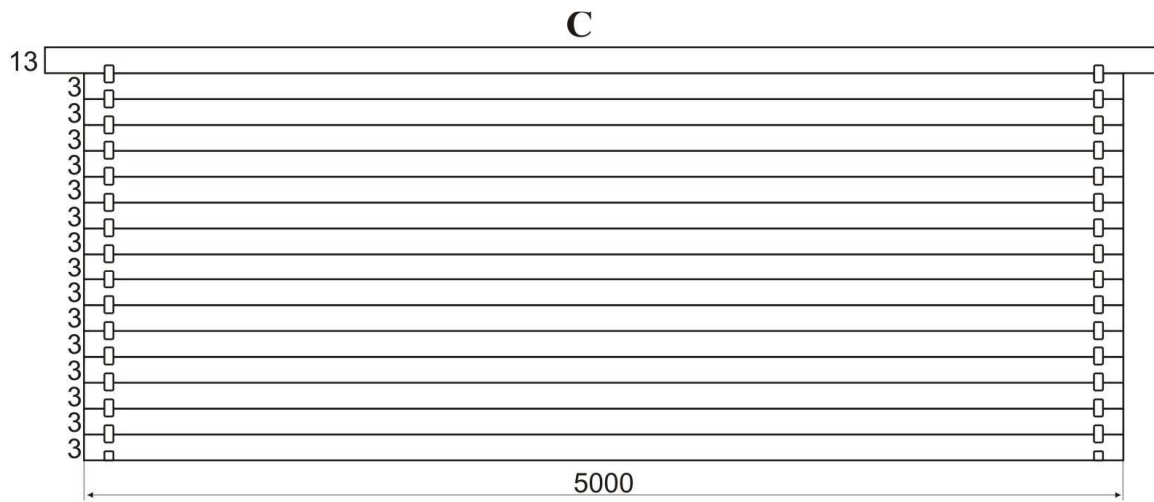

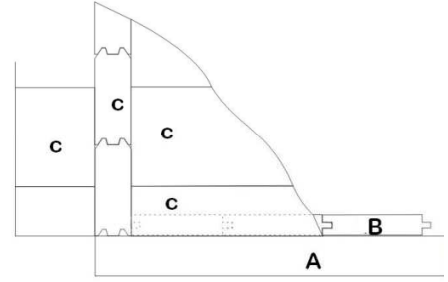
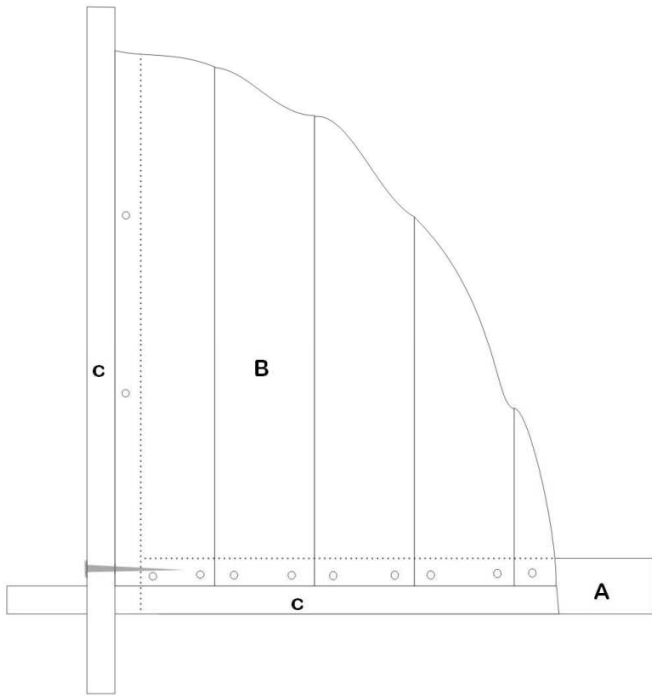

- A, - Bearers
- B, - Floor-boards
- C, - Wall-boards